

REAL TIME SECURITY CONTROL SYSTEM FOR SMOKE AND FIRE DETECTION USING ZigBee

Suneel Mudunuru^{#1}, V. Narasimha Nayak^{^2}, G.Madhusudhana Rao^{*3}, K.Sreenivasa Ravi^{§4}

[#] Department of Electronics and Communication Engineering, K L University, Vaddeswaram, Guntur, Andhra Pradesh, India.

^{*} Department of Electronics and Communication Engineering, NVR CET, Tenali, A.P, India.

[§] Department of Electronics and Computers Engineering, K L University, Vaddeswaram, Guntur, Andhra Pradesh, India.

Abstract- A smoke detector or smoke alarm is a device that detects smoke and issues a alarm to alert nearby people that there is a potential fire. They can detect fire in their early stages and give you those precious minutes to enable you and your family to leave your house in safety. Wireless communication enables transfer of data or signals over part of the entire communication network. Wireless implementation of sensor network ensures safety in terms of saving lives and property. In this paper wireless sensor network is realized using ARM 7 based microcontroller. The LPC2148 is a very popular ARM7 microcontroller with 512 KB flash, 64 KB of RAM and with several I/O peripherals. When potential fire is detected, the smoke sensor sounds an alarm .It also transmits a signal wirelessly to other sensors in the network. The microcontroller form the main unit of the system .It receives input from the sensors and wirelessly sends information to other sensors in the network to sound an alarm thereby preventing any disaster from occurring. GNU ARM/Keil compiler will be used for building the applications. LPC2148 development board will be used to test the built application. Additional sensors and wireless nodes will be used to demonstrate the complete setup.

Keywords- Photoelectric Smoke Detectors, Wireless Detector Network, ARM 7 LPC2148 Micro Controllers.

1. INTRODUCTION

Sensor networks become more and more popular as cost of sensor gets cheaper and cheaper. The sensor network is a wireless network formed by a group of sensors deployed in same region, which can be used to measure air pressure, temperature, acceleration, etc. Sensors transmit signals via radio signal. Since sensors are now small and cheap, they can be deployed on a large scale. They become more and more important for applications like security, traffic monitoring, agriculture, battlefield, etc. Most of those sensors are powered by batteries. The lifespan of an energy-constrained sensor is determined by how fast the sensor consumes energy. Sensors use energy to run circuitry and send radio signals. The later is

usually a function of distance and takes a large portion of the energy. Researchers are now developing new routing mechanisms for sensor networks to save energy and prolong the sensor lifespan. Four primary routing mechanisms are direct transmission, minimum energy transmission, static clustering and dynamic clustering. Sensor lifespan is an important performance index for comparison of different routing mechanisms. So far, the comparison between routing mechanisms is based on simulation results. Very few analytical results are available.

A wireless sensor device is a battery-operated device, capable of sensing physical quantities. In addition to sensing, it is capable of wireless communication, data storage, and a limited amount of computation and signal processing. Advances in integrated circuit design are continually shrinking the size, weight and cost of sensor devices, while simultaneously improving their resolution and accuracy. At the same time, modern wireless networking technologies enable the coordination and networking of a large number of such devices. In this paper a system was implemented which provides security control system for smoke and fire detection using wireless sensor network (WSN). A Wireless Sensor Network (WSN) consists of a large number of wireless sensor devices working collaboratively to achieve a common objective. A WSN has one or more sinks (or Base Stations) which collect data from all sensor devices. These sinks are the interface through which the WSN interacts with the outside world. The basic premise of a WSN is to perform networked sensing using a large number of relatively unsophisticated sensors, instead of the conventional approach of deploying a few expensive and sophisticated sensing modules. The potential advantage of networked sensing over the conventional approach can be summarized as greater coverage, accuracy and reliability at a possibly lower cost. WSNs can also facilitate controlling of physical environments from remote locations with better accuracy. Sensor nodes have various energy and computational constraints because of their inexpensive nature and ad-hoc method of deployment. In this

paper for sensing the smoke, smoke sensors are used. Sensitivity of smoke is usually accomplished in several ways. Either ionization, photoelectric or a combination of both depends on the type of detector. The source of power for wireless smoke detectors found in the home is powered by disposable batteries. Although the National Fire Protection Association (NFPA) recommends a smoke alarm be installed in every room, it is more common to have interconnected smoke alarms throughout the house. If you wish to comply with the NFPA recommendation, most wireless smoke alarms will allow you to add additional units wherever you think they are required. Generally, when one alarm is activated, all the alarms will sound. Smoke alarms save lives, property loss. It's simply an early warning system that protects you, your family and your property. Any investment returns benefits an untold number of times simply because you'll never know when it's needed until it's needed. The two most used wireless smoke detectors are the photoelectric and the ionization models. They are optical detection and physical process devices, respectively. The ionization models react rapidly to the presence of flames and are more useful when a fast moving fire is present. Smoky, smoldering fires are sensed more readily by the optical smoke alarm devices. Dual sensor smoke alarms will contain elements of both technologies. The USFA recommends a combination of photoelectric and ionization smoke detectors which can be achieved with a dual sensor type. There are also alarms that support the hearing impaired. A flashing strobe light design or vibration type sensor are the most common for those who cannot hear the usual smoke alarm warning beeps or tones. At a minimum smoke alarms should be installed on each level of your home. This should include basements and attics as well. Unpredictability is a usual characteristic of a fire. Most fires occur early in the morning or the wee hours of night. Therefore, sleeping areas are the first most important wireless smoke alarm locations to consider, both inside the room and just outside. Be sure to consult your manufacturer with regard to height and location recommendations that can produce the most effective warning at the appropriate time. Wireless smoke detectors are widely available at your local hardware store and any of the many available home improvement stores. Recommendations from your local fire department are a good source for helping you determine the best type of smoke detector for your home. Occasionally, given the right circumstances your local fire department may offer smoke detectors for your home at more reasonable prices than the stores mentioned above. Wireless smoke detectors powered by a battery are easily installed. The only tool you're likely to need is a screwdriver. Others may only require removing the backing and sticking directly onto the surface of a desired location. Wireless smoke detectors are linked together and when one alarm is activated it can send signals to all the other alarms so they will be activated as well. They are valuable tools in the early detection of fires. Each individual detector has the ability to transmit information to other similar units which gives you added protection and speeds your notification time. This in turn increases your response time

and may provide more time to react to an alarm and to escape a fire. Never ignore any alarm signal until you have completely eliminated in threat of fire. If an alarm goes off accidentally, see if you can determine why it went off and correct the matter.

If we can put wireless smoke detectors all around your home, and they ring together using ZigBee technology. They ring together. So when one smoke alarm sounds, they will all sound. They will provide an earlier warning to fire. If you are in your bedroom and a fire starts in your kitchen, the smoke alarm outside of your kitchen will trigger the smoke alarms up in your bedroom." These units are a bit more expensive than traditional smoke detectors, but they do come with increased benefits. Each wireless smoke alarm has a receiver and a transmitter in it. So, they can talk to each other. Previously, sensor networks consisted of small number of sensor nodes that were wired to a central processing station. However, nowadays, the focus is more on wireless, distributed, sensing nodes. But, why distributed, wireless sensing? When the exact location of a particular phenomenon is unknown, distributed sensing allows for closer placement to the phenomenon than a single sensor would permit. Also, in many cases, multiple sensor nodes are required to overcome environmental obstacles like obstructions, line of sight constraints etc. In most cases, the environment to be monitored does not have an existing infrastructure for either energy or communication. It becomes imperative for sensor nodes to survive on small, finite sources of energy and communicate through a wireless communication channel. The information gathering capabilities of distributed sensor networks are poised to revolutionize the way the information infrastructure interacts with our physical environment. In the majority of applications, locating sensors is also critical. An alarm from a sensor may be meaningless unless the source is identified and located. If devices are to be dropped into place or moved periodically users should not be required to input each device ID and its coordinates, nor should the user interface identify devices by number. In fact, a device's location can become its ID. Location of a device will be relative to its neighbours, which it will cooperatively calculate based on peer-to-peer range measurements. Furthermore, sensor data fusion and processing algorithms will reduce and make decisions based on the relative location of input data. Another requirement for sensor networks would be distributed processing capability. This is necessary since communication is a major consumer of energy. A centralized system would mean that some of the sensors would need to communicate over long distances that lead to even more energy depletion. Hence, it would be a good idea to process locally as much information as possible in order to minimize the total amount of information to be transmitted.

2. HARDWARE IMPLEMENTATION

To realize a smoke detector unit and network system using ARM 7 microcontroller we require total four blocks.

1. Input devices
2. Output devices

- 3. Control panel
- 4. Power supply

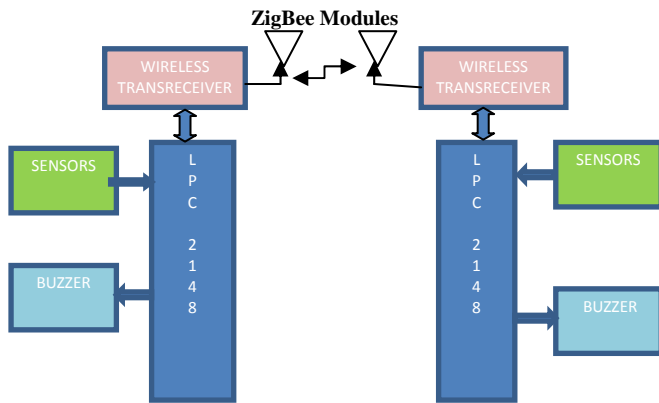

Fig 1. Block diagram of Wireless Sensor Network

A. Input devices

In input devices we require smoke detectors and temperature sensors for detecting smoke and fire during any fire accident. Opto-Coupler is used to detect the smoke and LM35 temperature sensor is used for sensing the temperature.

1) *Opto-Coupler:* An opto-isolator, also called an optocoupler, photocoupler, or optical isolator, is an electronic device designed to transfer electrical signals by utilizing light waves to provide coupling with electrical isolation between its input and output. The main purpose of an opto-isolator is to prevent high voltages or rapidly changing voltages on one side of the circuit from damaging components or distorting transmissions on the other side. Commercially available opto-isolators withstand input-to-output voltages up to 10 kV and voltage transients with speeds up to 10 kV/μs. An opto-isolator contains a source (emitter) of light, almost always a near infrared light-emitting diode (LED), that converts electrical input signal into light, a closed optical channel (also called dielectrical channel), and a photo sensor, which detects incoming light and either generates electric energy directly, or modulates electric current flowing from an external power supply. The sensor can be a photo resistor, a photodiode, a phototransistor, a silicon-controlled rectifier (SCR) or a triac. Because LEDs can sense light in addition to emitting it, construction of symmetrical, bidirectional opto-isolators is possible. An optocoupled solid state relay contains a photodiode opto-isolator which drives a power switch, usually a complementary pair of MOSFET transistors. The slotted optical switch, sometimes known as opto switch or optical switch but not to be confused with the optical component, is a device comprising a semiconductor photo emitter and photo detector mounted in a single package so that the photo emitter normally illuminates the photo detector, but an opaque object can be inserted in a slot between them so as to break the beam

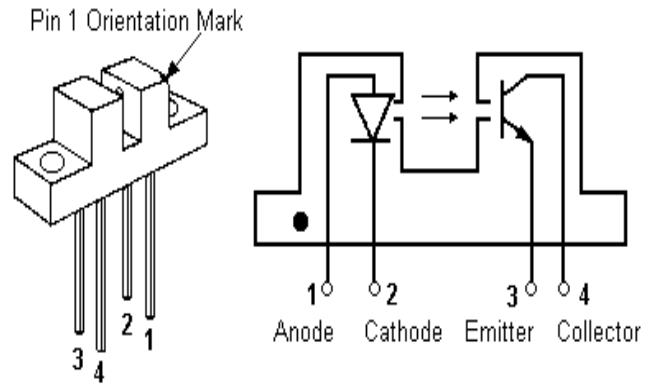

Fig 2. Photo detectors

2) *LM35 - Temperature Sensor:* The LM35 series are precision integrated-circuit temperature sensors, whose output voltage is linearly proportional to the Celsius (Centigrade) temperature. The LM35 thus has an advantage over linear temperature sensors calibrated in ° Kelvin, as the user is not required to subtract a large constant voltage from its output to obtain convenient Centigrade scaling. The LM35 does not require any external calibration or trimming to provide typical accuracies of ±¼°C at room temperature and ±¾°C over a full -55 to +150°C temperature range. Low cost is assured by trimming and calibration at the wafer level. The LM35's low output impedance, linear output, and precise inherent calibration make interfacing to readout or control circuitry especially easy. It can be used with single power supplies, or with plus and minus supplies. As it draws only 60 μA from its supply, it has very low self-heating, less than 0.1°C in still air. The LM35 is rated to operate over a -55° to +150°C temperature range, while the LM35C is rated for a -40° to +110°C range (-10° with improved accuracy). The LM35 series is available packaged in hermetic TO-46 transistor packages, while the LM35C, LM35CA, and LM35D are also available in the plastic TO-92 transistor package. The LM35D is also available in an 8-lead surface mount small outline package and a plastic TO-220 package.

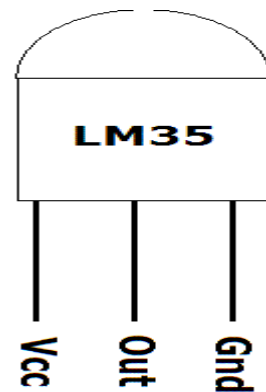

Fig 3. Temperature Sensor

B. Output devices

In output devices we require Buzzers for alerting people and Wireless module for sending signal to other nodes. To

achieve wireless communication here ZigBee module is used. To generate alarm sound here we used Buzzer Alarm.

1) **ZIGBEE:** There are a multitude of standards like Bluetooth and Wi-Fi that address mid to high data rates for voice, PC LANs, video, etc. However, up till now there hasn't been a wireless network standard that meets the unique needs of sensors and control devices. Sensors and controls don't need high bandwidth but they do need low latency and very low energy consumption for long battery lives and for large device arrays. There are a multitude of proprietary wireless systems manufactured today to solve a multitude of problems that don't require high data rates but do require low cost and very low current drain. These proprietary systems were designed because there were no standards that met their application requirements. These legacy systems are creating significant interoperability problems with each other and with newer technologies. The ZigBee Alliance is not pushing a technology; rather it is providing a standardized base set of solutions for sensor and control systems. The physical layer was designed to accommodate the need for a low cost yet allowing for high levels of integration. The use of direct sequence allows the analog circuitry to be very simple and very tolerant towards inexpensive implementations. The media access control (MAC) layer was designed to allow multiple topologies without complexity. The power management operation doesn't require multiple modes of operation. The MAC allows a reduced functionality device (RFD) that needn't have flash nor large amounts of ROM or RAM. The MAC was designed to handle large numbers of devices without requiring them to be "parked". The network layer has been designed to allow the network to spatially grow without requiring high power transmitters. The network layer also can handle large amounts of nodes with relatively low latencies. ZigBee is poised to become the global control/sensor network standard. It has been designed to provide the following features.

1. Low power consumption, simply implemented
2. Users expect batteries to last many months to years

Consider that a typical single family house has about 6 smoke/CO detectors. If the batteries for each one only lasted six months, the home owner would be replacing batteries every month!

1. In contrast to Bluetooth, which has many different modes and states depending upon your latency and power requirements, ZigBee/IEEE 802.15.4 has two major states: active (transmit/receive) or sleep. The application software needs to focus on the application, not on which power mode is optimum for each aspect of operation.
2. Even mains powered equipment needs to be conscious of energy. ZigBee devices will be more ecological than their predecessors saving megawatts at it full deployment. Consider a future home that has 100 wireless control/sensor devices,

Case 1: 802.11 Rx power is 667 mW (always on) @ 100 devices/home & 50,000 homes/city = 3.33 megawatts

Case 2: 802.15.4 Rx power is 30 mW (always on) @ 100 devices/home & 50,000 homes/city = 150 kilowatts

Case 3: 802.15.4 power cycled at .1% (typical duty cycle) = 150 watts

3. Low cost to the users means low device cost, low installation cost and low maintenance.
4. ZigBee devices allow batteries to last up to years using primary cells (low cost) without any chargers (low cost and easy installation). ZigBee's simplicity allows for inherent configuration and redundancy of network devices provides low maintenance.
5. High density of nodes per network
6. ZigBee's use of the IEEE 802.15.4 PHY and MAC allows networks to handle any number of devices. This attribute is critical for massive sensor arrays and control networks.
7. Simple protocol, global implementation

ZigBee's protocol code stack is estimated to be about 1/4th of Bluetooth's or 802.11's. Simplicity is essential to cost, interoperability, and maintenance. The IEEE 802.15.4 PHY adopted by ZigBee has been designed for the 868 MHz band in Europe, the 915 MHz band in N America, Australia, etc; and the 2.4 GHz band is now recognized to be a global band accepted in almost all countries.

I) ZigBee/IEEE 802.15.4 - General Characteristics

- Dual PHY (2.4GHz and 868/915 MHz)
- Data rates of 250 kbps (@2.4 GHz), 40 kbps (@ 915 MHz), and 20 kbps (@868 MHz)
- Optimized for low duty-cycle applications (<0.1%)
- CSMA-CA channel access yields high throughput and low latency for low duty cycle devices like sensors and controls
- Low power (battery life multi-month two years)
- Multiple topologies: star, peer-to-peer, mesh
- Addressing space of up to: - 18,450,000,000,000,000 devices (64 bit IEEE address) - 65,535 networks
- Optional guaranteed time slot for applications requiring low latency
- Fully hand-shaked protocol for transfer reliability
- Range: 50m typical (5-500m based on environment)

II) ZigBee/IEEE802.15.4 - Typical Traffic Types Addressed

- Periodic data
 - Application defined rate (e.g., sensors)
 - Intermittent data
 - Repetitive low latency data
 - Allocation of time slots (e.g., mouse)
- Each of these traffic types mandates different attributes from the MAC. The IEEE802.15.4 MAC is flexible enough to handle each of these types.
- Periodic data can be handled using the beaconing system whereby the sensor will wake up for the beacon, check for any messages and then go back to sleep.
 - Intermittent data can be handled either in a beaconless system or in a disconnected fashion. In a disconnected

operation the device will only attach to the network when it needs to communicate saving significant energy.

- Low latency applications may choose to the guaranteed time slot (GTS) option. GTS is a method of QoS in that it allows each device a specific duration of time each Super frame to do whatever it wishes to do without contention or latency.

The IEEE 802.15.4 PHY and MAC along with ZigBee's Network and Application Support Layer provide:

- Extremely low cost
- Ease of implementation
- Reliable data transfer
- Short range operation
- Very low power consumption
- Appropriate levels of security

There are two physical device types for the lowest system cost. The IEEE standard defines two types of devices:

- Full function device (FFD)
 - Can function in any topology
 - Capable of being the network coordinator
 - Capable of being a coordinator
 - Can talk to any other device
- Reduced function device (RFD)
 - Limited to star topology
 - Cannot become a network coordinator
 - Talks only to a network coordinator
 - Very simple implementation

An IEEE 802.15.4/ZigBee network requires at least one full function device as a network coordinator, but endpoint devices may be reduced functionality devices to reduce system cost.

- All devices must have 64 bit IEEE addresses
- Short (16 bit) addresses can be allocated to reduce packet size
- Addressing modes:
 - Network + device identifier (star)
 - Source/destination identified (peer to peer).

C) Control panel

In control panel the total function and controlling is done by ARM7 LPC2148 microcontroller. A microprocessor system consists of a microprocessor with memory, input ports and output ports connected to it externally. A microcontroller is a single chip containing a microprocessor, memory, input ports and output ports. Since all four blocks reside on the one chip, a microcontroller is much faster than a microprocessor system. We have several other basic microcontroller families such as PIC, M68HCXX, and AVR etc. All these basic microcontrollers are useful for implementing basic interfacing and control mechanisms for simple applications. There are several applications which require lot of computation and high speed data processing. In such applications advanced microcontrollers and microprocessors are used. One such advanced architecture is ARM. ARM stands for Advanced RISC machine. The first processor in ARM family was developed at Acorn Computers Ltd between October 1983 and April 1985. Acorn Computers was a British computer company established in Cambridge, England, in 1978. The company worked for Reduced Instruction Set Computer (RISC) processor design.

1) *ARM Architecture:* The ARM core uses RISC architecture. Its design philosophy is aimed at delivering simple but powerful instructions that execute within a single cycle at a high clock speed. The RISC philosophy concentrates on reducing the complexity of instructions performed by the hardware because it is easier to provide greater flexibility and intelligence in software rather than hardware. As a result RISC design plays greater demands on the compiler. In contrast, the traditional complex instruction set computer (CISC) relies more on the hardware for instruction functionality, AND consequently the CISC instructions are more complicated.

Certain design features have been characteristic of most RISC processors.

- *One Cycle Execution Time:* RISC processors have a CPI (clock per instruction) of one cycle. This is due to the optimization of each instruction on the CPU. Each instruction is of a fixed length to allow the pipeline to fetch future instructions before decoding the current instruction.

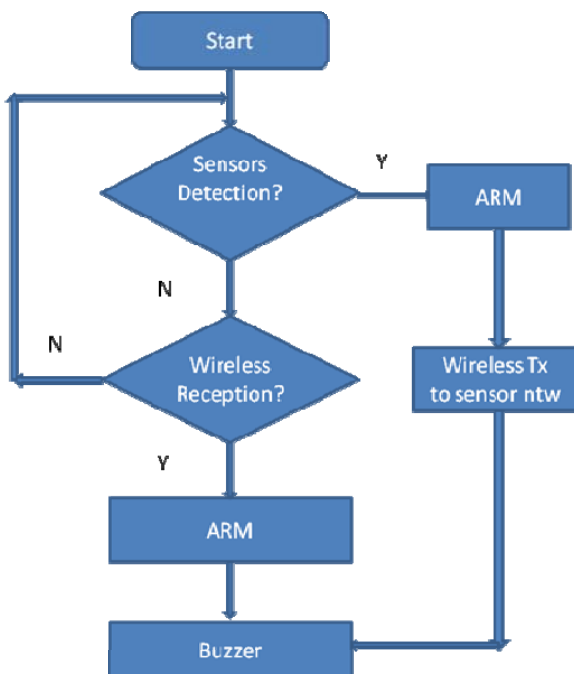

Fig 4. Flow chart or program flow.

- *Pipelining*: The processing of instructions is broken down into smaller units that can be executed in parallel by pipelines. Ideally the pipeline advances by one step on each cycle for maximum throughput. Instructions can be decoded in one pipeline stage.
- *Large Number of Registers*: The RISC design philosophy generally incorporates a larger number of registers to prevent large amount of interactions with memory. Any register can contain either data or an address. Registers act as the fast local memory store for all data processing operation.

I) AMBA (Advanced Microcontroller Bus Architecture) Bus Protocol: AMBA Bus was introduced in 1996 and has been widely adopted as the On Chip bus architecture used for ARM processors.

The first AMBA buses were

1. ARM System Bus (ASB)
2. ARM Peripheral Bus (APB)

Later ARM introduced another bus design called the ARM High performance Bus (AHB).

Using AMBA

1. Peripheral designers can reuse the same design on multiple projects
2. A Peripheral can simply be bolted on the On Chip bus without having to redesign an interface for different processor architecture.

This plug-and-play interface for hardware developers improves availability and time to market.

AHB provides higher data throughput than ASB because it is based on centralized multiplexed bus scheme rather than the ASB bidirectional bus design. This change allows the AHB bus to run at widths of 64 bits and 128 bits

ARM introduced two variations on the AHB bus

1. Multi-layer AHB
2. AHB-Lite

In contrast to the original AHB, which allows a single bus master to be active on the bus at any time, the Multi-layer AHB bus allows multiple active bus masters.

AHB-Lite is a subset of the AHB bus and it is limited to a single bus master. This bus was developed for designs that do not require the full features of the standard AHB bus. AHB and Multiple-layer AHB support the same protocol for master and slave but have different interconnects. The new interconnects in Multi-layer AHB are good for systems with multiple processors. They permit operations to occur in parallel and allow for higher throughput rates.

II) Introduction to ARM7TDMI Core: The ARM7TDMI core is a 32-bit embedded RISC processor delivered as a hard macro cell optimized to provide the best combination of performance, power and area characteristics.

(a) 2.3.6. ARM7TDMI Features

- 32/16-bit RISC architecture (ARM v4T)
- 32-bit ARM instruction set for maximum performance and flexibility
- 16-bit Thumb instruction set for increased code density
- Unified bus interface, 32-bit data bus carries both

instructions and data

- Three-stage pipeline
- 32-bit ALU
- Very small die size and low power consumption
- Coprocessor interface
- Extensive debug facilities (Embedded ICE debug unit accessible via JTAG interface unit)
- Generic layout can be ported to specific process technologies
- Unified memory bus simplifies SoC integration process
- ARM and Thumb instructions sets can be mixed with minimal overhead to support application requirements for speed and code density
- Code written for ARM7TDMI-S is binary-compatible with other members of the ARM7 Family and forwards compatible with ARM9, ARM9E and ARM10 families, thus it's quite easy to port your design to higher level microcontroller or microprocessor
- Static design and lower power consumption are essential for battery -powered devices
- Instruction set can be extended for specific requirements using coprocessors
- Embedded ICE-RT and optional ETM units enable extensive, real-time debug facilities

III) LPC2148 (ARM7) Microcontroller: The LPC2148 microcontrollers are based on a 32 bit ARM7TDMI-S CPU with real-time emulation and embedded trace support, that combines the microcontroller with embedded high speed flash memory of 512 kB. A 128-bit wide memory interface and unique accelerator architecture enable 32-bit code execution at the maximum clock rate. For critical code size applications, the alternative 16-bit Thumb mode reduces the code by more than 30 % with minimal performance penalty. Due to their tiny size and low power consumption, LPC2148 microcontrollers are ideal for the applications where miniaturization is a key requirement, such as access control and point-of-sale. A blend of serial communications interfaces ranging from a USB 2.0 Full Speed device, multiple UARTS, SPI, SSP to I2Cs and on-chip SRAM of 8 kB up to 40 kB, make these devices very well suited for communication gateways and protocol converters, soft modems, voice recognition and low end imaging, providing both large buffer size and high processing power. Various 32-bit timers, single or dual 10-bit ADC(s), 10-bit DAC, PWM channels and 45 fast GPIO lines with up to nine edge or level sensitive external interrupt pins make these microcontrollers particularly suitable for industrial control and medical systems.

Features of LPC2148 Microcontroller:

- 16/32-bit ARM7TDMI-S microcontroller in a tiny LQFP64 package.
- 8 to 40 kB of on-chip static RAM and 32 to 512 kB of on-chip flash program memory.

- 128 bit wide interface/accelerator enables high speed 60 MHz operation.
 - In-System/In-Application Programming (ISP/IAP) via on-chip boot-loader software. Single flash sector or full chip erase in 400 ms and programming of 256 bytes in 1 ms.
 - Embedded ICE RT and Embedded Trace interfaces offer real-time debugging with the on-chip Real Monitor software and high speed tracing of instruction execution.
 - USB 2.0 Full Speed compliant Device Controller with 2 kB of endpoint RAM.
- In addition, the LPC2146/8 provides 8 kB of on-chip RAM accessible to USB by DMA.
- One or two (LPC2141/2 vs. LPC2144/6/8) 10-bit A/D converters provide a total of 6/14 analog inputs, with conversion times as low as 2.44 μ s per channel.
 - Single 10-bit D/A converter provide variable analog output.
 - Two 32-bit timers/external event counters (with four capture and four compare channels each), PWM unit (six outputs) and watchdog.
 - Low power real-time clock with independent power and dedicated 32 kHz clock input.
 - Multiple serial interfaces including two UARTs (16C550), two Fast I2C-bus (400 Kbits/s), SPI and SSP with buffering and variable data length capabilities.
 - Vectored interrupt controller with configurable priorities and vector addresses..
 - Up to nine edge or level sensitive external interrupt pins available.
 - 60 MHz maximum CPU clock available from programmable on-chip PLL with settling time of 100 μ s.
 - On-chip integrated oscillator operates with an external crystal in range from 1 MHz to 30 MHz and with an external oscillator up to 50 MHz.
 - Power saving modes include Idle and Power-down.
 - Individual enable/disable of peripheral functions as well as peripheral clock scaling for additional power optimization.
 - Processor wake-up from Power-down mode via external interrupt, USB, Brown-Out Detect (BOD) or Real-Time Clock (RTC).
 - Single power supply chip with Power-On Reset (POR) and BOD circuits: CPU operating voltage range of 3.0 V to 3.6 V (3.3 V \pm 10 %) with 5 V tolerant I/O pads.

3. SOFTWARE IMPLEMENTATION

In this paper the heart of the control unit is ARM7 LPC2148 microcontroller. In this microcontroller it has 64 pins. Among 64 pins 45 pins are used for general purpose functions and those pins are called as general purpose I/O pins.

These pins perform multi functions. By dumping appropriate program into microcontroller these pins are used for specific and desired functions. The program which is used to dump into microcontroller is written in Embedded C language. This Embedded C program is simulated (Build) by using Keil software. The Keil software is used to convert Embedded C program into HEX file. After the simulation of Embedded C program the HEX file is stored in the same target location from where we browse the Embedded C program. After converting Embedded C program into HEX file we need to dump that hex file into microcontroller. For achieving this we use software called Flash Magic. The Flash Magic software is used to dump hex file into microcontroller. By dumping the hex file into microcontroller we achieve the required functionality.

Click for KEIL μ VISION4 Icon which appearing after Installing Keil KEIL μ VISION4.

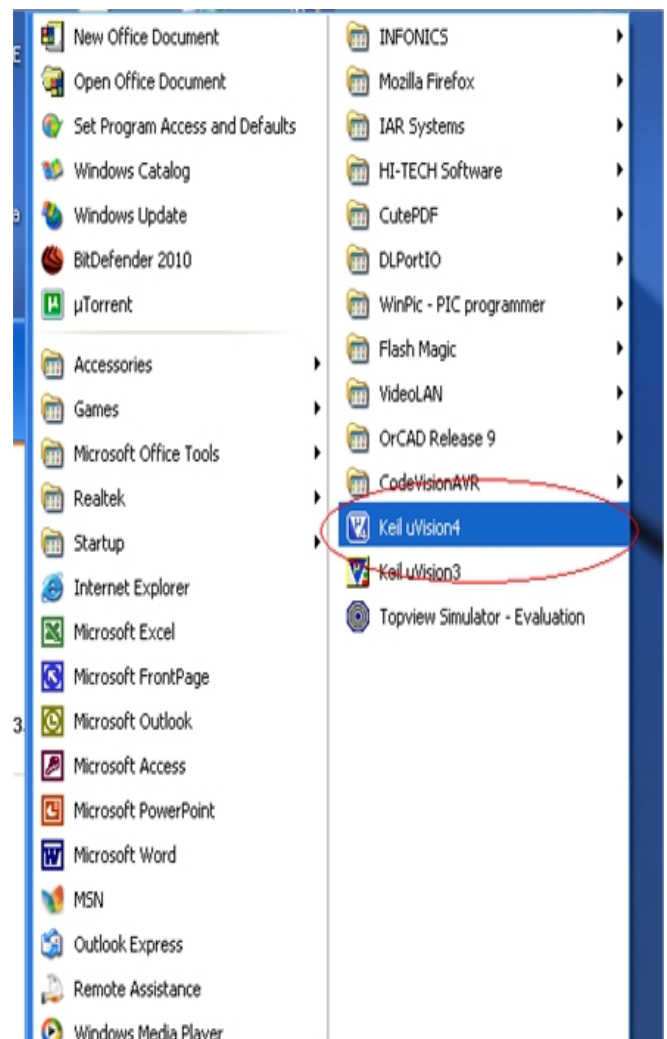

Fig 5. Opening new KEIL μ VISION4 window

After opening the KEIL μ VISION4, browse the all target files form target location to new KEIL μ VISION4 empty window. Click on Rebuild All Target Files.

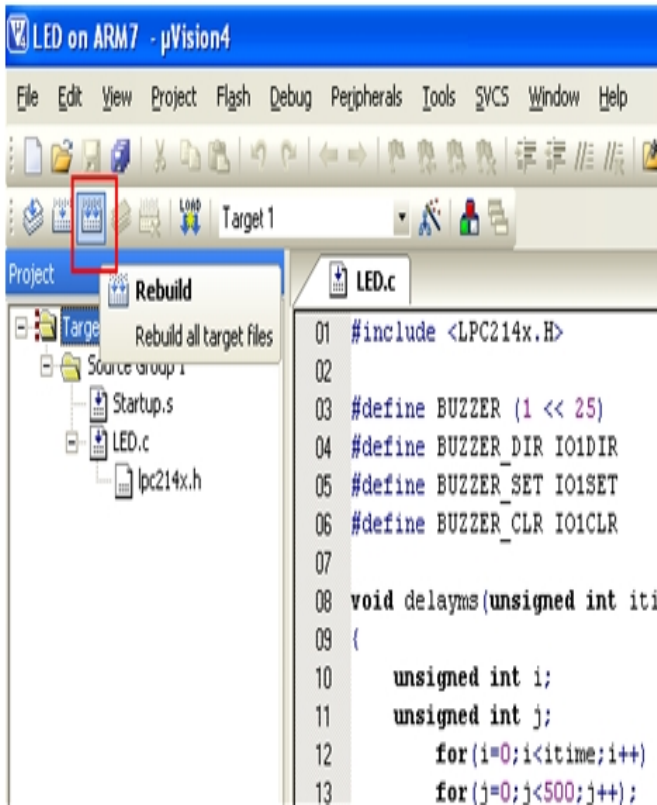

Fig 6. Rebuilding all target files

After click on Rebuild button the Embedded C code is execute and the result is displayed. If code has no errors then the result window displays 0 errors and 0 warnings.

Now you see 0 Error(s), 0 Warning (s). Then Hex File will create in Specific Folder. Now to download it for you target hardware

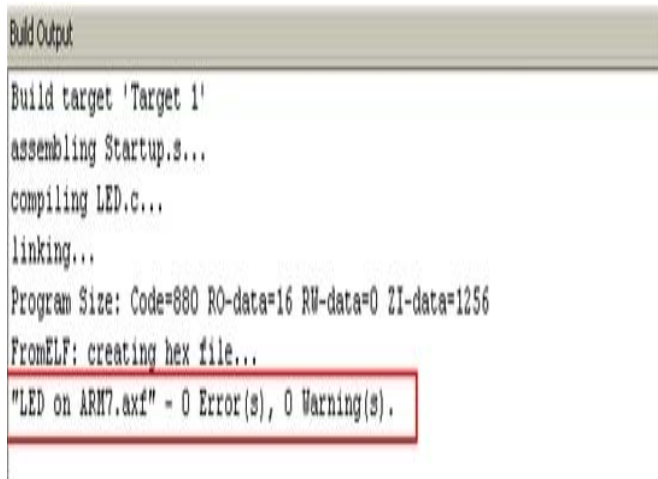

Fig 7. Errors and Warnings displaying window

Downloading HEX file

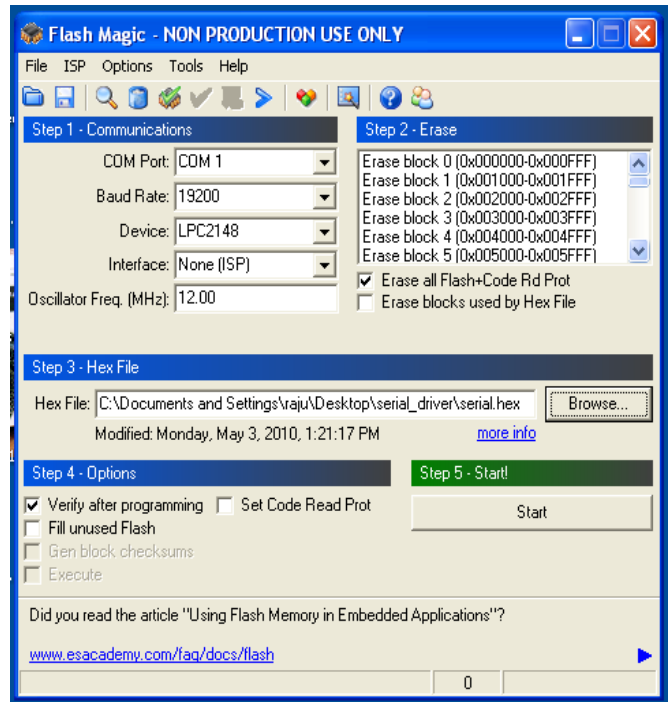

Fig 8. Flash magic window

To download the hex file into the microcontroller board we use software called **Flash magic tool**.

To dump the HEX file into microcontroller by using Flash Magic the following procedure is followed.

Step 1-Communications

Set COM Port : COM1
 Baud Rate : 19200
 Device : LPC2148
 Interface : None (ISP)
 Oscillator Freq (MHz):12

Step 2-Erase

Select the box Erase all Flash + Code Rd Prot

Step 3-Hex File

Click on browse to load the **serial.hex** file from the folder **serial driver**.

Step 4-Options

Select the box Verify after programming.

Power up the microcontroller board using USB cable, make serial cable connection between PC and microcontroller's UART0 db9 connector.

To make the board enter programming mode

Hold down SW2 (isp) and SW3 (reset), then release SW3 first and finally SW2.

Step 5-Start

Click the Start button

4. RESULTS AND DISCUSSIONS

Transmitter side:

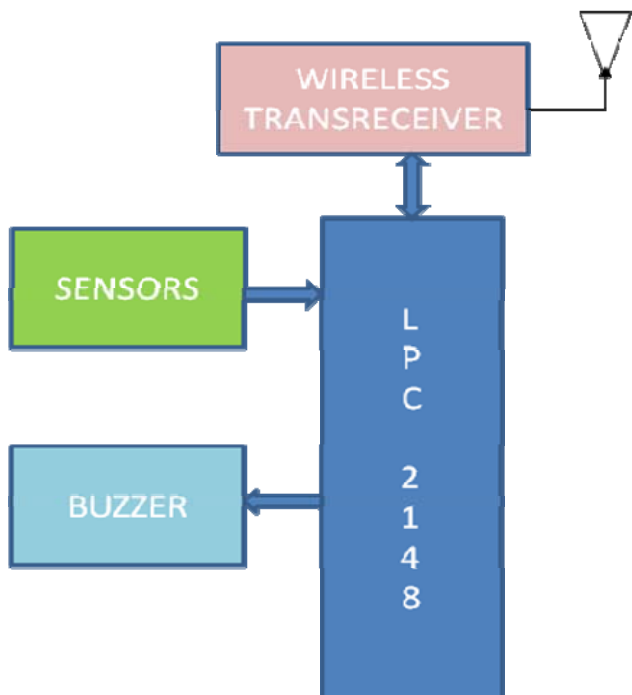

Fig 9. Transmitter Section

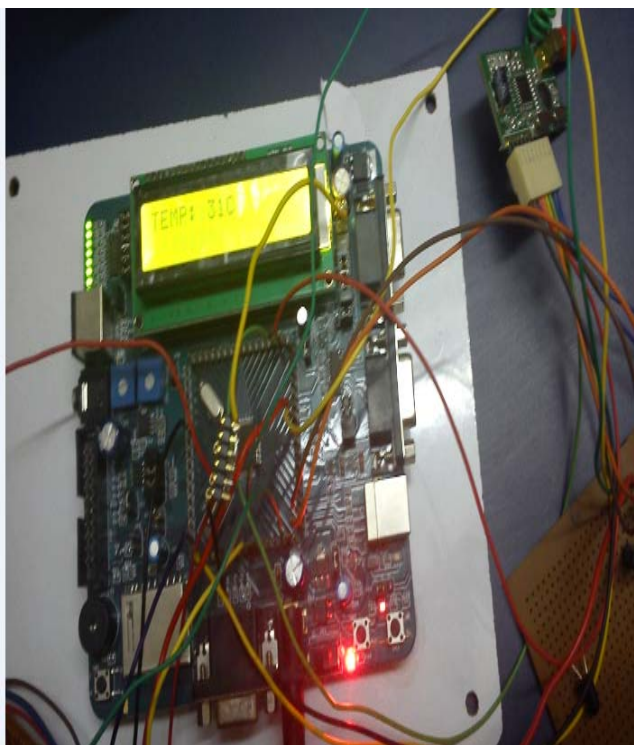

Fig 10. Hardware Implementation of Transmitter Section

COMPONENTS

These are the listed components of Fig 10.

1. OPTO COUPLER – SMOKE DETECTOR
 Connected to ADC 0.3
 Normal Digital output – 80
 In case of smoke detection – Above 200 (digital value)
 Output Display - HyperTerminal
2. LM35 – Temperature Sensor
 Connected to ADC 0.6
 Calculates Normal Temperature
 Sounds Alarm in case temperature goes above 45 C
 Output Display – LCD
3. BUZZER
 Connected to PWM Channel 2
 Sounds different tones of alarm depending upon which sensor is triggered
4. ZIGBEE MODULE
 Connected to UART 1

Transmits information in case of an alarm is triggered

Receiver Section:

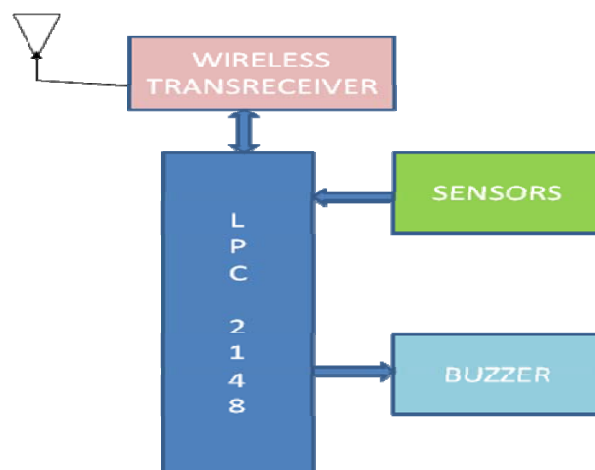

Fig 11. Receiver Section

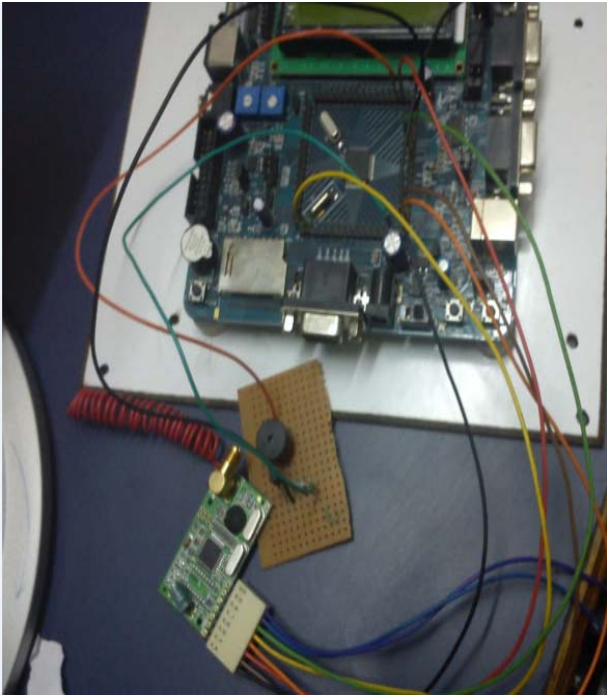

Fig 12. Hardware Implementation of Receiver Section

Whenever the transmitter sends any signal the receiver receives that signal and it alerts the people by ringing the buzzer. In this way by alerting people we can save lot of property loss and we can also save human lives.

5. CONCLUSIONS

A) Wireless Technology

Cable is expensive, less flexible than RF coverage and is prone to damage. For new facilities, implementing a wireless infrastructure may be more cost effective than running cable through industrial environments, especially if the space configuration may change to support different storage space allocation or flexible manufacturing stations.

B) ZigBee Communication

Real-time ZigBee communication include a significant improvement in order accuracy (>99%), the elimination of paperwork, replacement of time-consuming batch processing by rapid real-time data processing, prompt response times and

improved service levels. Complementing a real-time data collection system with automated data entry by bar code scanning or another automatic data collection technology improves the accuracy of information and eliminates the need for redundant data entry, which provides another set of time- and cost-saving advantages

C) ARM Controller

- Low power Consumption
- Low cost
- Execution speed is faster

D) Future Scope

The smoke detector system can be enhanced by connecting it with a personal computer for monitoring and controlling purposes and using the GSM (Global System for Mobile Communications) to send and receive an SMS (short message Service) from the place of the detector to the involved person. Therefore, improve the chances for reducing the risks to life and property

6. REFERENCES

- [1] Molla Shahadat Hossain Lipu, Md. Lushanur Rahman, Tahia Fahrin Karim, Faria Sultana, "Wireless Security Control System & Sensor Network for Smoke & Fire Detection", 2010 IEEE
- [2] Full-Scale House Fire Experiment for InterFIRE VR, Report of Test, A.D. Putorti Jr and J. McElroy, November 2, 1999, Revised April 10, 2000.
- [3] 2003 NFPA world safety conference 'May 20 2003' Smoke Detection system performance. Dan Gottuk..
- [4] Fire Detection Systems www.osha.gov.
- [5] Application of Wireless Sensor Mote for Building Risk Monitoring, N. Kurata, B. F. Spencer, Jr, and M. Ruiz-Sandoval, Presentations/P8.pdf, (2003).
- [6] On Random Event Detection with Wireless Sensor Networks, P. K. Dutta, Master's Thesis, Ohio State University, 2004.
- [7] Wireless Sensor Networks, pt I: Introduction, Eliana Stavrou <http://webhosting.devshed.com/c/aiWeb-Hosting-Articles/WirelessSensor-Networks-pt-I-Introduction>.
- [8] LM35 data sheet, www.national.com/pf/LM/LM35.html